

# Chapter 10

## Braking system

### Contents

ABS module - removal and refitting	25	Hydraulic unit fluid reservoir - removal and refitting	16
Brake discs - inspection	4	Hydraulic unit hoses - removal and refitting	20
Brake hydraulic system - bleeding	2	Hydraulic unit pressure switch - removal and refitting	19
Brake hydraulic system - fluid renewal	3	Hydraulic unit pump and motor - removal and refitting	18
Brake pedal - removal and refitting	14	Master cylinder (April 1992 on) - removal and refitting	27
Brake pipes and hoses - inspection, removal and refitting	21	Pedal Travel Sensor (PTS) (April 1992 on) - removal and refitting	32
Control module (April 1992 on) - removal and refitting	31	Rear brake disc - removal and refitting	6
Front brake disc - removal and refitting	5	Rear brake pads - inspection and renewal	8
Front brake pads - inspection and renewal	7	Rear caliper - overhaul	12
Front caliper - overhaul	10	Rear caliper - removal and refitting	11
Front caliper - removal and refitting	9	Rear disc splash shield - removal and refitting	13
G (gravity) switch (April 1992 on) - removal and refitting	33	Vacuum servo unit (April 1992 on) - testing, removal and refitting	28
General information	1	Vacuum servo unit check valve (April 1992 on) - removal, testing and refitting	29
Handbrake cable - adjustment	22	Valve block and pump assembly (April 1992 on) - removal and refitting	30
Handbrake cable - removal and refitting	23	Wheel sensors - removal and refitting	26
Handbrake control lever - removal and refitting	24		
Hydraulic unit - removal and refitting	15		
Hydraulic unit accumulator - removal and refitting	17		

### Degrees of difficulty

<b>Easy</b> , suitable for novice with little experience 	<b>Fairly easy</b> , suitable for beginner with some experience 	<b>Fairly difficult</b> , suitable for competent DIY mechanic 	<b>Difficult</b> , suitable for experienced DIY mechanic 	<b>Very difficult</b> , suitable for expert DIY or professional 
---	--	--	---	--

### Specifications

#### General

System type: .....

Discs all round, hydraulic operation, anti-lock braking system (ABS). Handbrake by mechanical operation of rear calipers

System make:

Models up to April 1992 .....

Models from April 1992 .....

Teves MK II ABS

Teves MK IV ABS

#### Hydraulic system

Fluid type .....

Operating pressure .....

Pressure warning switch operates at .....

Hydraulic fluid to Ford spec SAM-6C9103-A

130 to 190 bar (1885 to 2755 lbf/in<sup>2</sup>)

100 to 110 bar (1450 to 1595 lbf/in<sup>2</sup>)

#### Brake pads

Lining minimum thickness .....

1.5 mm (0.06 in)

#### Brake discs

Run-out .....

Thickness variation .....

Minimum thickness:

Front .....

Rear .....

Rear - Estate models .....

0.15 mm (0.006 in) maximum

0.015 mm (0.0006 in) maximum

22 mm (0.87 in)

Cast into outer rim (typically 8.9 mm/0.35 in)

18 mm (0.71 in)

## 10•2 Braking system

### Torque wrench settings

	Nm	lbf ft
Front caliper:		
To stub axle carrier	51 to 61	38 to 45
Slide bolts	20 to 25	15 to 18
Rear caliper:		
Bracket to carrier plate	51 to 61	38 to 45
Slide bolts	31 to 35	23 to 26
Hydraulic unit to bulkhead	41 to 51	30 to 38
Accumulator to pump body	35 to 45	26 to 33
Pump mounting bolts	7 to 9	5 to 7
High pressure hose banjo bolts	16 to 24	12 to 18
Reservoir mounting bolts	4 to 6	3 to 4
Wheel sensor fixing bolts	8 to 11	6 to 8
Vacuum servo unit retaining nuts (Teves MK IV)	35 to 45	26 to 33
Master cylinder retaining nuts (Teves MK IV)	20 to 25	15 to 18
Valve block and pump assembly mounting nuts (Teves MK IV)	21 to 28	15 to 21

### 1 General information

Models covered in this Manual have disc brakes fitted all round. The footbrake operates hydraulically on all four wheels, and the handbrake operates mechanically on the rear wheels. Both footbrake and handbrake are self-adjusting in use.

Ford's anti-lock braking system (ABS) is fitted to all models. The system monitors the rotational speed of each roadwheel. When a wheel begins to lock under heavy braking, the ABS reduces the hydraulic pressure to that wheel, so preventing it from locking. When this happens a pulsating effect will be noticed at the brake pedal. On some road surfaces the tyres may squeal when braking hard even though the wheels are not locked.

The main components of the system are the hydraulic unit, the calipers, pads and discs, the wheel sensors and the "brain" or control module. The hydraulic unit contains the elements of a traditional master cylinder, plus an electric motor and pump, a pressure accumulator and control valves. The pump is the source of pressure for the system and does away with the need for a vacuum servo.

The hydraulic circuit is split front and rear, as is normal practice with rear-wheel drive vehicles. In the event that the hydraulic pump fails, unassisted braking effort is still available on the front calipers only.

Warning lights inform the driver of low brake fluid level, ABS failure and (on some models) brake pad wear. The low fluid level light doubles as a "handbrake on" light; if it illuminates at the same time as the ABS warning light, it warns of low hydraulic pressure.

ABS cannot overturn the laws of physics: stopping distances will inevitably be greater on loose or slippery surfaces. However, the system should allow even inexperienced drivers to retain directional control under panic braking.

From August 1986 the following modifications were made to the braking system.

a) *The relays differ from earlier versions.*

b) *The hydraulic pump is constructed of iron rather than alloy.*

c) *A new pressure warning switch is used.*

d) *The earlier high pressure rubber hose is replaced by a steel pipe.*

To overcome the problem of excessive rear brake pad wear, Ford introduced a differential valve which is screwed into the ABS valve block. The valve limits the pressure applied to the rear brake calipers and so reduces brake pad wear. From 1988 onwards, the valve has been fitted during production. The differential valve can also be fitted to earlier models. Refer to your Ford dealer for further information.

From April 1992 onwards, the models covered in this Manual were equipped with a new Teves MK IV anti-lock braking system instead of the Teves MK II system fitted to the earlier models.

The Teves MK IV system differs from the earlier MK II system in the following ways.

a) *The source of hydraulic pressure for the system is a conventional master cylinder and vacuum servo assembly.*

b) *A valve block and pump assembly is used instead of the hydraulic control unit. The block contains the inlet and outlet solenoid valves that control the hydraulic system. There are three pairs of valves, one for each brake circuit (paragraph c).*

c) *The hydraulic braking system consists of three separate circuits; one for each front brake (which are totally independent of each other), and a joint circuit which operates both rear brakes.*

d) *A G (gravity) switch is incorporated in the system. This is an inertia type switch and informs the control module when the vehicle is decelerating rapidly.*

e) *A Pedal Travel Sensor (PTS) is fitted to the vacuum servo unit. The PTS informs the control module of the position of the brake pedal when the anti-lock sequence starts and ensures that a constant pedal height is maintained during the sequence.*

The MK IV system operates as follows.

During normal operation the system functions in the same way as a non-ABS system would. During this time the three inlet valves in the valve block are open and the

outlet valves are closed, allowing full hydraulic pressure present in the master cylinder to act on the main braking circuit. If the control module receives a signal from one of the wheel sensors and senses that a wheel is about to lock, it closes the relevant inlet valve in the valve block which then isolates the brake caliper on the wheel which is about to lock from the master cylinder, effectively sealing in the hydraulic pressure. If the speed of rotation of the wheel continues to decrease at an abnormal rate, the control module will then open the relevant outlet valve in the valve block; this allows the fluid from the relevant hydraulic circuit to return to the master cylinder reservoir, releasing pressure on the brake caliper so that the brake is released. The pump in the valve block also operates to assist in the quick release of pressure. Once the speed of rotation of the wheel returns to an acceptable rate the pump stops, the outlet valve closes and the inlet valve is opened, allowing the hydraulic master cylinder pressure to return to the caliper which then reapplies the brake. This cycle can be carried many times a second. The solenoid valves connected to the front calipers operate independently, but the valve connected to the rear calipers operates both calipers simultaneously.

The operation of the ABS system is entirely dependent on electrical signals. To prevent the system responding to any inaccurate signals, a built-in safety circuit monitors all signals received by the control module. If an inaccurate signal or low battery voltage is detected, the ABS system is automatically shut down and the warning lamp on the instrument cluster is illuminated to inform the driver that the ABS system is not operational. Whilst in this state the system functions in the same way as a non-ABS system would. If a fault does develop in the ABS system, the car must be taken to a Ford dealer for fault diagnosis and repair. The system is equipped with a diagnostic plug into which a special diagnostic (STAR) tester can be plugged. This allows faults to be easily traced.

## 2 Brake hydraulic system - bleeding



**Note:** Hydraulic fluid is poisonous; wash off immediately and thoroughly in the case of skin contact and seek immediate medical advice if any fluid is swallowed or gets into the eyes. Certain types of hydraulic fluid are inflammable and may ignite when allowed into contact with hot components; when servicing any hydraulic system it is safest to assume that the fluid is inflammable and to take precautions against the risk of fire as though it is petrol that is being handled. Finally, it is hygroscopic (it absorbs moisture from the air) old fluid may be contaminated and unfit for further use. When topping-up or renewing the fluid, always use the recommended type and ensure that it comes from a freshly-opened sealed container



**Haynes Hint** Hydraulic fluid is an effective paint stripper and will attack plastics; if any is spilt, it should be washed off

immediately using copious quantities of fresh water.

1 Bleeding is necessary whenever air has entered the hydraulic system - for instance after component renewal. Because the hydraulic circuits are split, if only the front or rear circuit has been disturbed it will normally only be necessary to bleed the front or rear calipers. If the hydraulic unit has been disturbed or the fluid level has been allowed to fall so low that air has entered the system, both front and rear circuits must be bled, starting with the front

2 The services of an assistant will be required. As far as is known, pressure bleeding or other "one-man" equipment cannot be used. In addition a supply of fresh brake fluid of the correct type will be needed, together with a length of flexible tube to fit the bleed screws and a clean glass or plastic container.

3 Do not allow the hydraulic unit pump motor to run for more than two minutes at a time. The motor must be allowed to cool (with the ignition off) for at least ten minutes after each two minute spell of running.

4 Remember that brake fluid is poisonous and that the rear brake hydraulic system may be under considerable pressure. Take care not to allow hydraulic fluid to spray into the face or eyes.

5 Keep the reservoir topped up to the MAX mark during bleeding.

6 Discard the fluid bled out of the system as it is unfit for re-use.

### Models before April 1992

#### Front brakes

7 Remove the dust cap (if fitted) from the left-hand caliper bleed screw. Slacken the bleed screw, then nip it up again. Make sure that the ignition is off.

8 Fit the bleed tube over the bleed screw. Place the other end of the tube in the bleed jar (glass or plastic container). Pour sufficient brake fluid into the jar to cover the end of the tube.

9 Open the bleed screw one full turn. Have the assistant depress the brake pedal as far as it will go, and hold it depressed. Tighten the bleed screw, then tell the assistant to release the pedal.

10 Repeat paragraph 9 until clean fluid, free of air bubbles, flows from the bleed screw during the downstrokes. Remember to keep the fluid reservoir topped up.

11 Repeat the operations on the right-hand caliper. Refit the bleed screw dust caps (if applicable) on completion.

#### Rear brakes

12 Remove the dust cap (if fitted) from the rear left-hand caliper bleed screw. Open the bleed screw one full turn.

13 Fit the bleed tube over the bleed screw. Place the other end of the tube in the bleed jar (see illustration).

14 Have the assistant depress the brake pedal as far as it will go and hold it down. Switch on the ignition: the hydraulic unit pump will start and fluid will flow from the bleed screw.

15 When clean fluid, free of air bubbles, emerges from the bleed screw, tighten the bleed screw and have the assistant release the pedal.

16 Wait for the hydraulic unit pump to stop, then top-up the reservoir and repeat the procedure on the right-hand caliper. This time the brake pedal should only be depressed half-way.

17 Switch off the ignition, top-up the reservoir again and refit the reservoir cap. Refit the bleed screw dust caps (if applicable).

### Models from April 1992

18 This operation can be carried out using the information given above in paragraphs 1 to 10, ignoring the reference to the hydraulic unit pump and bearing in mind the following.

19 Note that if only one circuit is disturbed it will only be necessary to bleed that relevant circuit on completion.

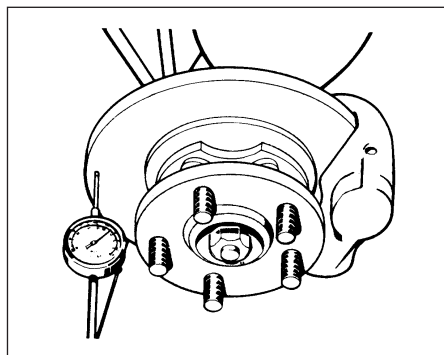

4.3 Measuring brake disc run-out



2.13 Bleeding a rear brake caliper

20 If the complete system is to be bled, it should be done in the following order.

- a) Left-hand front caliper.
- b) Right-hand front brake caliper.
- c) Left-hand rear caliper.
- d) Right-hand rear caliper.

## 3 Brake hydraulic system - fluid renewal

See Chapter 1, Section 44.

## 4 Brake discs - inspection

1 Whenever the brake pads are inspected, also inspect the brake discs for deep scratches, scores or cracks. Light scoring is normal and may be ignored. A cracked disc must be renewed; scratches and scores can sometimes be machined out, provided that the thickness of the disc is not reduced below the specified minimum.

2 When the brake pads are renewed, or if brake judder or snatch is noticed, check the discs for run-out and thickness variation. (Note that wheel bearing wear can cause disc run-out.)

3 Position a dial test indicator probe against the disc wear face, approximately 15 mm (0.6 in) in from the outer circumference. Zero the indicator, rotate the disc and read the run-out from the indicator (see illustration). Maximum run-out is given in the Specifications. If a dial test indicator is not available, use a fixed pointer and feeler blades.

4 Measure the thickness of the disc, using a micrometer, in eight evenly spaced positions around the disc. Maximum thickness variation is given in the Specifications. Renew the disc if the variation is out of limits.

## 5 Front brake disc - removal and refitting

1 Slacken the front wheel nuts, raise and support the vehicle and remove the relevant front wheel.

2 Remove the two bolts which hold the caliper bracket to the stub axle carrier. Lift the caliper



5.3 Disc-securing spring clip

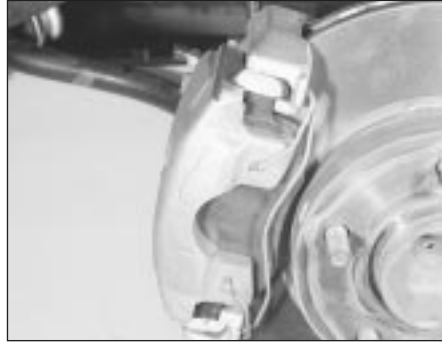

7.2 Spring clip fitted to outboard face of front caliper

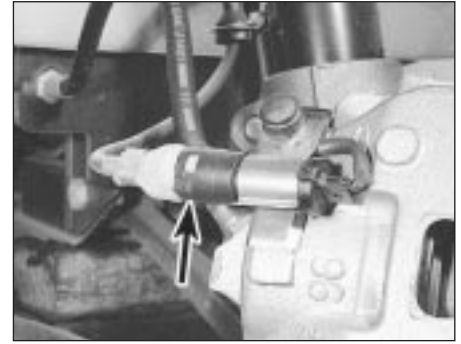

7.3 Pad wear warning multi-plug (arrowed) on front caliper

and bracket off the disc and tie them up out of the way. Do not allow the caliper to hang on the flexible hose.

3 Remove the spring clip which secures the disc (see illustration).

4 Mark the relationship of the disc to the hub if it is to be re-used, then remove the disc.

5 Refit by reversing the removal operations. Tighten the caliper bracket bolts to the specified torque, and check that the brake flexible hose is not kinked or fouling in any position of the steering wheel.

6 Pump the brake pedal to bring the pads up to the disc.

### 6 Rear brake disc - removal and refitting

1 Chock the front wheels and release the handbrake. Slacken the rear wheel nuts, raise and support the vehicle and remove the relevant rear wheel.

2 Free the handbrake cable from its clip in the suspension lower arm.

3 Remove the two bolts which secure the caliper bracket to the hub. Lift the caliper and bracket off the disc and suspend it without straining the flexible hose.

4 Remove the spring clip from the wheel stud. Mark the disc-to-hub relationship and remove the disc.

5 Refit by reversing the removal operations.

6 Pump the brake pedal to bring the pads up to the disc.

### 7 Front brake pads - inspection and renewal

1 Disc pads can be inspected without removing the front wheels, using a mirror and a torch through the aperture in the rear face of the caliper. If any one pad is worn down to the minimum specified, all four pads (on both front wheels) must be renewed.

2 To renew the pads, first remove the front wheels, then prise free the spring clip from the outboard face of a caliper (see illustration).

3 Disconnect the pad wear warning wires, when fitted (see illustration).

4 Unscrew the two caliper slide bolts, using a 7 mm hexagon key, until the caliper is free of the bracket (see illustration).

5 Lift the caliper off the disc and remove the pads (see illustration). Support the caliper so that the flexible hose is not strained. Do not press the brake pedal with the caliper removed.

6 Clean the dust and dirt from the caliper, bracket and disc, using a damp cloth or old paintbrush which can be thrown away afterwards. **Take care not to disperse the dust into the air, or to inhale it, since it may contain asbestos.** Scrape any scale or rust from the disc. Investigate any hydraulic fluid leaks.

7 Push the caliper piston back into its housing, using the fingers or a blunt instrument, to accommodate the extra thickness of the new pads.

8 Fit the new pads to the caliper, being careful not to contaminate the friction surfaces with oil



7.4 Undoing a caliper slide bolt

or grease. The inboard pad has a spring clip which fits into the piston recess; the outboard pad must have its backing paper peeled off, after which the pad should be stuck to the other side of the caliper (see illustrations).

9 Fit the caliper and pads over the disc and onto the caliper bracket. Tighten the slide bolts to the specified torque.

10 Reconnect the wear warning wires, if fitted.

11 Refit the spring clip to the caliper.

12 Repeat the operations on the other caliper, then refit the wheels and lower the vehicle. Tighten the wheel nuts.

13 Pump the brake pedal several times to bring the pads up to the disc, then check the brake fluid level.

14 Avoid heavy braking as far as possible for the first hundred miles or so to allow the new pads to bed in.



7.5 Lifting a front caliper off the disc

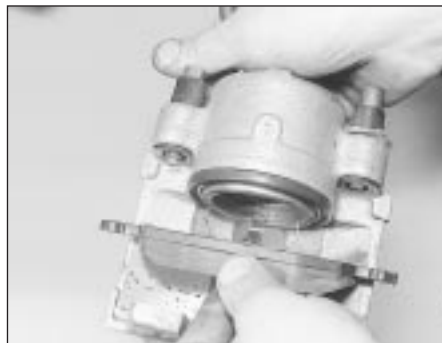

7.8a Clipping the inboard front pad into the piston



7.8b Both pads fitted to a front caliper





8.3 Undoing a rear caliper front slide bolt



8.4 Pad wear warning multi-plug (arrowed) on rear caliper



8.5 Removing a rear brake pad

## 8 Rear brake pads - inspection and renewal

1 It is necessary to remove the rear wheels in order to inspect the rear pads. The pads can be viewed through the top of the caliper after removing the spring clip. If any one pad is worn down to the minimum specified, all four pads (on both rear wheels) must be renewed.

2 Free the handbrake cable from its clip on the suspension lower arm. Release the handbrake.

3 Remove the caliper slide bolt nearest the front, counter-holding the slide pin with another spanner (see illustration).

4 Disconnect the pad wear warning wires, when fitted (see illustration).

5 Swing the caliper rearwards and remove the pads (see illustration). Do not press the brake pedal with the caliper removed.

6 Clean the dust and dirt from the caliper, bracket and disc, using a damp cloth or old paintbrush which can be thrown away afterwards. **Take care not to disperse the dust into the air, or to inhale it, since it may contain asbestos.** Scrape any scale or rust from the disc. Investigate any hydraulic fluid leaks.

7 Retract the caliper piston, by turning it clockwise, to accommodate the extra thickness of the new pads. There is a Ford tool (No 12-006) for this purpose, but a pair of circlip pliers or any similar tool can be used instead (see illustration).

8 Remove any backing paper from the new

pads, then fit them to the caliper bracket. Be careful not to contaminate the friction surfaces with oil or grease.

9 Swing the caliper over the pads. Refit and tighten the slide bolt.

10 Reconnect the wear warning wires, if fitted.

11 Repeat the operations on the other rear caliper.

12 Secure the handbrake cable, refit the wheels and lower the vehicle. Tighten the wheel nuts.

13 Switch on the ignition and pump the brake pedal several times to bring the pads up to the discs. Switch off the ignition and check the operation of the handbrake.

14 Avoid heavy braking as far as possible for the first hundred miles or so to allow the new pads to bed in.

## 9 Front caliper - removal and refitting

1 With the ignition off, pump the brake pedal at least 20 times (or until it becomes hard) to depressurise the hydraulic system.

2 Slacken the front wheel nuts, raise and support the vehicle and remove the relevant front wheel.

3 Slacken the flexible hose hydraulic union at the caliper by no more than a quarter turn.

4 Remove the brake pads (Section 7).

5 The caliper can now be removed by holding the flexible hose stationary and rotating the caliper to unscrew it. Be prepared for hydraulic fluid spillage: plug or cap the caliper and hose.

A brake hose clamp may be used if available (see illustration). Take great care to keep dirt out of the hydraulic system.

6 The caliper bracket may be unbolted from the stub axle carrier if wished.

7 Refit by reversing the removal operations, but before refitting the wheel, check the positioning of the flexible hose. It must not be kinked, nor foul adjacent components, in any position of the steering wheel. Release the other end of the hose from its bracket if necessary and reposition it.

8 Bleed both front brake calipers as described in Section 2.

## 10 Front caliper - overhaul

1 It is possible to carry out these operations without disconnecting the caliper hydraulic hose, but this is not recommended because of the risk of introducing dirt into the hydraulic system. Scrupulous cleanliness is essential.

2 Obtain a caliper repair kit, which will contain a piston seal and a dust boot. (The piston itself can also be renewed if necessary.)

3 Remove the piston from the caliper. This is best done with low air pressure (eg from a foot pump) applied to the hydraulic inlet union. Place a piece of wood opposite the piston to prevent damage, and keep your fingers clear as the piston may be ejected with some force.

4 With the piston removed, pull off the dust boot (see illustration).



8.7 Rotating the caliper piston to retract it



9.5 Removing a front caliper - note clamp on brake hose



10.4 Removing the dust boot from a front caliper



10.5 Removing the piston seal



10.9 Pressing the piston into the bore



11.5a Unhook the handbrake cable . . .

5 Extract the piston seal from the groove in the bore, using a blunt instrument (see illustration). Discard the seal and dust boot.

6 Clean the piston and bore with methylated spirit and inspect them for scuffs, scores or other damage. If the piston is corroded it must be renewed. Slight imperfections in the bore can be polished out with wire wool.

7 Place the clean component on a clean surface ready for reassembly. Lubricate the caliper hose with clean hydraulic fluid.

8 Fit the new piston seal to the groove in the bore, using fingers only to work it into position.

9 Lubricate the piston with clean hydraulic fluid and fit the dust boot over the piston, making sure it is the right way up. Insert the piston into the bore and press it home, engaging the dust boot lip with the groove on the caliper (see illustration).

10 This completes the overhaul of the hydraulic components. Items such as slide bolts and bracket can also be renewed if necessary.

11 Remove the bleed screw while the caliper is on the bench and apply a little anti-seize compound to its threads, to avoid trouble in undoing it later.

and support the vehicle and remove the relevant wheel.

3 Disconnect the pad wear warning wires, when fitted.

4 Disconnect the flexible hose from the brake pipe. Plug or cap the open unions to reduce spillage and to keep dirt out. Unscrew the flexible hose from the caliper and remove it.

5 Remove the two slide bolts. Lift the caliper off the pads and bracket, at the same time unhooking the handbrake cable (see illustrations). Alternatively, the two bracket-to-hub bolts can be removed and the caliper and bracket separated on the bench.

6 Refit by reversing the removal operations, but before refitting the wheel, bleed both rear calipers as described in Section 2.

7 When bleeding is complete, pump the brake pedal several times to bring the pads up to the disc, then check the operation of the handbrake.



11.5b . . . and remove the rear caliper

protruding from the bore by about 20 mm (0.8 in). Free the dust boot from the groove in the piston, then carry on unscrewing the piston and remove it. Remove and discard the dust boot.

3 The piston and bore may now be cleaned and examined, and the piston seal and dust boot renewed, as described for the front caliper (Section 10).

4 The piston adjuster nut seal should also be renewed. Remove the circlip from the piston, then extract the thrustwashers, wave washer and thrust bearing. Note the fitted sequence of these components. Finally remove the nut (see illustrations).

5 Remove the seal from the nut, noting which way round it is fitted. Clean the nut with methylated spirit. Lubricate the new seal with clean hydraulic fluid and fit it to the nut.

### 11 Rear caliper - removal and refitting



1 With the ignition off, pump the brake pedal at least 20 times (or until it becomes hard) to depressurise the system.

2 Chock the front wheels and release the handbrake. Slacken the rear wheel nuts, raise

### 12 Rear caliper - overhaul



*Note: Complete dismantling of the rear caliper should not be attempted unless Ford spring compressor (tool No 12-007) is available, or unless the problems likely to arise in the absence of the tool are understood. Renewal of the piston seal and dust boot requires no special tools.*

1 Clean the caliper externally and mount it in a soft-jawed vice.

2 Rotate the piston anti-clockwise until it is



12.4a Removing the circlip from a rear caliper piston . . .



12.4b . . . followed by a thrustwasher . . .



12.4c . . . a wave washer and (not shown) another thrustwasher . . .



12.4d . . . the thrust bearing . . .

12.4e . . . and the adjuster nut itself  
*Note seal (arrowed) on nut*

12.6 Using the adjuster nut to compress the caliper spring

6 For further dismantling it is virtually essential to have Ford tool 12-007. This tool appears to be a cut-down adjuster nut with a handle for turning it. In the workshop it was found that the piston adjuster nut could be used to compress the spring if it were turned with circlip pliers (*see illustration*). This works well enough for dismantling, but reassembly proved extremely difficult because of the limited clearance between the skirt of the nut and the caliper bore.

7 Having compressed the adjuster spring just enough to take the load off the circlip, release the circlip inside the caliper bore. Remove the spring compressor, then extract the circlip, spring cover, spring and washer (*see illustrations*).

8 A long thin pair of circlip pliers will now be needed to release the key plate retaining circlip from the caliper bore (*see illustration*). With the circlip removed, the pushrod and key plate can be pulled out.

9 Remove the handbrake strut from the caliper bore.

10 Remove the handbrake lever return spring and stop bolt. Pull the lever and shaft nut out of the caliper. Prise out the shaft seal.

11 Clean up the handbrake shaft using wire wool; renew the shaft if it is badly corroded. The shaft bush in the caliper can also be renewed if necessary. Pull out the old bush with an internal puller or slide hammer; press in the new bush to 7.5 mm (0.30 in) below the shaft seal lip (*see illustration*). The slot in the side of the bush must line up with the pushrod bore in the caliper.

12 Having renewed components as necessary, commence reassembly by smearing a little brake grease or anti-seize compound on the handbrake shaft and bush.

13 Fit a new handbrake shaft seal to the caliper. Pass the shaft through the seal and into the caliper, being careful not to damage the seal lips.

14 Refit the handbrake lever stop bolt and return spring.

15 Refit the handbrake strut, lubricating it with brake grease.

16 Fit a new O-ring to the base of the pushrod. Refit the pushrod and the key plate, engaging the pip on the key plate with the recess in the caliper. Secure the key plate with the circlip.



12.7a Extract the circlip . . .



12.7b . . . the spring cover . . .



12.7c . . . the spring itself . . .



12.7d . . . and the washer

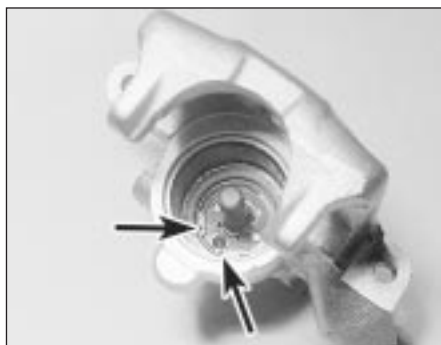

12.8 Remove the circlip (ends arrowed) to release the pushrod and key plate

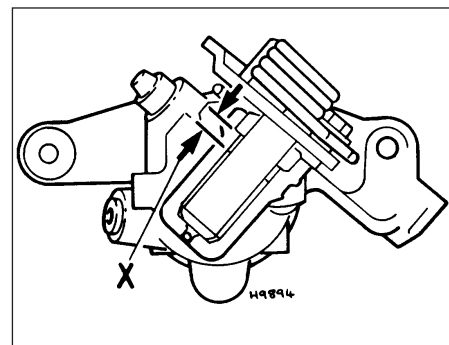
12.11 Handbrake shaft bush correctly fitted  
*X = 7.5 mm (0.30 in)*





12.21 Dust boot fitted to caliper and piston

17 Refit the washer, spring and spring cover. Compress the spring and refit the circlip, then release the spring compressor.

18 Lubricate the caliper bore with clean hydraulic fluid and fit a new piston seal.

19 Reassemble the piston components. Lubricate the contact face of the adjuster nut with a little brake grease, then fit the adjuster nut (with new seal), thrust bearing, thrustwasher, wave washer and the second thrustwasher. Secure with the circlip.

20 Fit a new dust boot. The manufacturers recommend that it be fitted to the caliper groove and the piston fitted afterwards; it is also possible to fit the boot to the piston first and engage it in the caliper groove afterwards. Either way it is a fiddly business.

21 Refit the piston and screw it into the caliper, then fit whichever lip of the dust boot was left free (see illustration).

22 Renew the slide pin gaiters and apply a little anti-seize compound to the slide pins when reassembling the caliper to the bracket.

### 13 Rear disc splash shield - removal and refitting

The splash shield is retained by the rear hub bolts. Proceed as described in Chapter 11 for removal and refitting of the rear hub.

### 14 Brake pedal - removal and refitting

- 1 Disconnect the battery negative lead.
- 2 Depressurise the hydraulic system by pumping the brake pedal at least 20 times, or until it becomes hard.
- 3 Remove the under-dash trim on the driver's side.
- 4 Remove the spring clip which secures the hydraulic unit pushrod to the brake pedal. Also remove the clip from the brake pedal shaft (see illustration).
- 5 Withdraw the brake pedal shaft towards the left of the vehicle - through the clutch pedal, when applicable - until the brake pedal is free.
- 6 Remove the pedal, noting the fitted sequence of bushes, spacers and washers.
- 7 Refit by reversing the removal operations. Check the correct functioning of the stop-light and (if applicable) cruise control switches before refitting the trim. See Chapter 13.

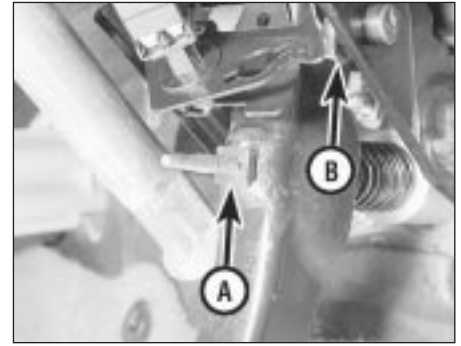

14.4 Pushrod spring clip (A) and brake pedal shaft clip (B)

### 15 Hydraulic unit - removal and refitting

- 1 Disconnect the battery negative lead.
- 2 Depressurise the hydraulic system by pumping the brake pedal at least 20 times, or until it becomes hard.
- 3 Disconnect the six multi-plugs from the hydraulic unit. They are all different, so there is no need to label them. When a plug has a spring clip retainer, lift the clip before pulling out the plug. To release the pump plug, pull back the rubber boot and the plug sleeve (see illustrations).
- 4 Unbolt the earth strap from the unit (see illustration).
- 5 Make arrangements to catch spilt hydraulic



15.3a Disconnect the valve block multi-plug. Lift the clip and pull off the plug



15.3b Disconnecting a fluid level sensor plug



15.3c Disconnecting the main valve plug



15.3d Disconnecting the pressure switch multi-plug



15.3e Disconnecting the pump motor plug

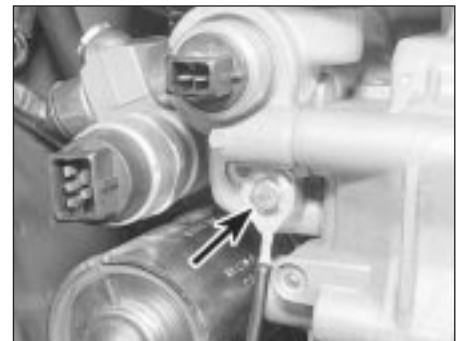

15.4 Earth strap (arrowed) bolted to hydraulic unit



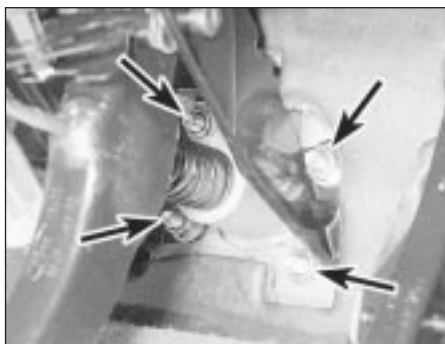

15.7 Four nuts (arrowed) which hold the hydraulic unit to the bulkhead

fluid. Identify the hydraulic pipes and disconnect them from the base of the unit.

Hint: Plug or cap the open unions to keep fluid in and dirt out.

6 Remove the under-dash trim on the driver's side. Disconnect the spring clip which secures the hydraulic unit pushrod to the brake pedal.

7 Have an assistant support the hydraulic unit. Remove the four nuts which hold the unit to the bulkhead (see illustration). Withdraw the unit from under the bonnet.

8 Recover the sealing compound from the unit and the bulkhead.

9 Drain the hydraulic fluid from the reservoir. Do not actuate the pushrod with the unit removed.

10 Dismantling of the hydraulic unit should be limited to the operations described in the

following Sections. These operations can all be carried out without removing the unit from the vehicle if wished.

11 Refit by reversing the removal operations, noting the following points:

- Do not refill the reservoir until the end of refitting
- Use new sealing compound between the unit and the bulkhead
- Make sure that the hydraulic pipes are reconnected to the correct unions
- Bleed the complete hydraulic system on completion - see Section 2

## 16 Hydraulic unit fluid reservoir - removal and refitting

1 Disconnect the battery negative lead.

2 Depressurise the hydraulic system by pumping the brake pedal at least 20 times, or until it becomes hard.

3 Disconnect the multi-plugs and remove the reservoir cap.

4 Remove the reservoir securing screw, which is located just above the valve block multi-plug (see illustration).

5 Make arrangements to catch spilt fluid, then disconnect the low pressure hose from its connections to the pump. The hose is secured by a spring clip (see illustrations). Allow the brake fluid to drain out of the hose.

6 Pull the reservoir out of the seals on the hydraulic unit and remove it (see illustration).

7 Note the spigot locating bush on the rear inlet union, which may stay in the hydraulic unit or may come out with the reservoir (see illustration).

8 Refit by reversing the removal operations. Use new seals between the hydraulic unit and the reservoir.

9 Bleed the complete hydraulic system on completion (Section 2). Check for leaks around the disturbed components.

## 17 Hydraulic unit accumulator - removal and refitting

1 Disconnect the battery negative lead.

2 Depressurise the hydraulic system by pumping the brake pedal at least 20 times, or until it becomes hard.

3 Wrap a clean rag round the base of the accumulator to catch any spilt fluid.

4 Unscrew the accumulator using a hexagon key. Remove the accumulator, being prepared for fluid spillage (see illustration).

5 When refitting, fit a new O-ring to the base of the accumulator. Fit the accumulator and tighten it.

6 Reconnect the battery. Switch on the ignition and check that the hydraulic unit pump stops within 60 seconds. If not, there may be something wrong with the accumulator.

7 Bleed the complete hydraulic system as described in Section 2.



16.4 Undoing the reservoir securing screw



16.5a Extract the spring clip . . .



16.5b . . . and disconnect the hose



16.6 Removing the hydraulic fluid reservoir



16.7 The spigot locating bush fits into this union



17.4 Removing the accumulator  
Note O-ring (arrowed)



18.5 Hydraulic unit pump mounting bolt

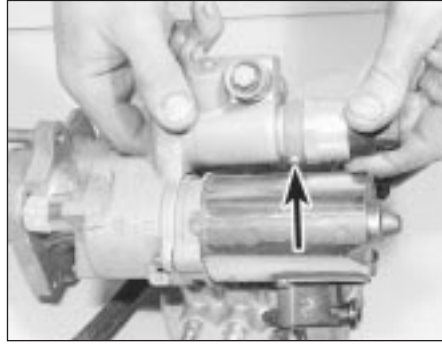

19.4 Refitting the pressure switch  
Hole (arrowed) in sleeve must face pump motor



20.9 Fitting new sealing washers to a banjo union

## 18 Hydraulic unit pump and motor - removal and refitting



- 1 Remove the accumulator (Section 17).
- 2 Disconnect the high pressure hose from the pump. Be prepared for fluid spillage.
- 3 Disconnect the low pressure hose from the pump. Allow the fluid to drain out of the reservoir through the hose.
- 4 Disconnect the multi-plugs from the pressure switch and the pump motor.
- 5 Remove the pump mounting bolt (see illustration).
- 6 Pull the pump and motor assembly off the mounting spigot and remove it.
- 7 Recover the mounting bushes and renew them if necessary.
- 8 If a new pump is to be fitted, transfer the pressure switch to it, using a new O-ring.
- 9 Commence refitting by offering the pump to the spigot, then reconnecting the low pressure hose.
- 10 Refit and tighten the pump mounting bolt.
- 11 Reconnect the high pressure hose, using new sealing washers on the banjo union.
- 12 Refit the accumulator, using a new O-ring.
- 13 Reconnect the multi-plugs and the battery.
- 14 Refill the reservoir, then switch on the ignition and allow the pump to prime itself. Do not let the pump run for more than two minutes - see Section 3. Check for leaks around the disturbed components.
- 15 Bleed the complete system (Section 2).

## 19 Hydraulic unit pressure switch - removal and refitting



**Note:** To remove the pressure switch from the hydraulic unit in situ, Ford tool No 12-008, or equivalent, will be required. The switch may be removed without special tools after removing the hydraulic unit complete (Section 16) or the pump (Section 18).

- 1 Disconnect the battery negative lead.
- 2 Depressurise the hydraulic system by pumping the brake pedal at least 20 times, or until it becomes hard.
- 3 Disconnect the multi-plug from the switch, then unscrew and remove it.

- 4 When refitting, use a new O-ring on the switch. Position the plastic sleeve so that the hole in the sleeve is facing the pump motor (see illustration). Tighten the switch.
- 5 Reconnect the multi-plug and the battery.
- 6 Bleed the complete system (Section 2).

## 20 Hydraulic unit hoses - removal and refitting



- 1 There are two hoses on the hydraulic unit. The low pressure hose connects the reservoir to the pump inlet; the high pressure hose connects the pump outlet to the booster and valve block.
- 2 To remove either hose, first disconnect the battery. Depressurise the hydraulic system by pumping the brake pedal at least 20 times, or until it becomes hard.

### Low pressure hose

- 3 Have ready a container to catch spilt fluid. Remove the spring clip and pull the hose off the pump inlet. Allow the contents of the reservoir to drain out of the hose and into the container.
- 4 Pull the hose off the reservoir and remove it.
- 5 Refit by connecting the hose to the reservoir and pump inlet. Secure the hose to the pump with the spring clip.
- 6 Refill the reservoir, reconnect the battery and bleed the complete system (Section 2). Check for leaks.



21.3 Undoing a rigid pipe union nut  
Flexible hose locknut is just above



21.4 Removing a flexible hose from its bracket

### High pressure hose

- 7 Remove the banjo bolts which secure the hose. Be prepared for fluid spillage.
- 8 Remove the hose and recover the sealing washers.
- 9 Refit by reversing the removal operations, using new sealing washers on both sides of each union (see illustration).
- 10 Reconnect the battery and bleed the complete system (Section 2). Check for leaks.

## 21 Brake pipes and hoses - inspection, removal and refitting



- 1 Periodically inspect the rigid brake pipes for rust and other damage, and the flexible hoses for cracks, splits or "ballooning". Have an assistant depress the brake pedal (ignition on) and inspect the hose and pipe unions for leaks. Renew defective items without delay.
- 2 Before removing any pipe or hose, depressurise the hydraulic system by switching off the ignition and pumping the brake pedal 20 times, or until it becomes hard.
- 3 To remove a flexible hose, first undo the union nut which secures the rigid pipe to it. The use of a split ring spanner, sold for this purpose, is recommended (see illustration). Be prepared for hydraulic fluid spillage, and take precautions to keep dirt out.
- 4 Having disconnected the rigid pipe, release the hose from the bracket by removing the locknut and washer (see illustration).



**21.5 Disconnecting the hose from the caliper**

5 Unscrew the hose from its union on the caliper and remove it (see illustration).

6 Refit by reversing the removal operations, then bleed the appropriate part of the hydraulic system (Section 2). In the case of the front hoses, check that they are not kinked or twisted, and that they do not contact other components when the steering is moved from lock to lock. Reposition the hose in the bracket if necessary.

7 To remove a rigid pipe, simply undo the union nuts at the hydraulic unit, hose bracket or T-piece (see illustration). Free the pipe from any retaining clips and remove it.

8 New pipes can be bought ready-made, with the unions attached. Some garages and motor factors will make up pipes to order, using the old pipe as a pattern. If purchasing proprietary pipes made of copper alloy or similar material, follow the manufacturer's instructions carefully concerning bending, provision of extra clips etc.

9 Fit and secure the new pipe and tighten the union nuts, bleed the appropriate part of the hydraulic system (Section 2).

## 22 Handbrake cable - adjustment

1 The handbrake is normally self-adjusting in use. Adjustment may be required to compensate for cable stretch over a long period, and is also necessary after fitting a new cable.



**21.7 Brake pipe union T-piece (arrowed)**

2 Chock the front wheels, release the handbrake and raise and support the rear of the vehicle.

3 Release the adjuster locknut from the adjuster nut. Back off the adjuster nut, slackening the cable until both handbrake levers on the calipers are resting against their stops (see illustration).

4 Paint alignment marks between each handbrake lever and the caliper body (see illustration).

5 Tighten the adjuster nut until either handbrake lever just starts to move - as shown by the alignment marks.

6 Apply the handbrake and release it a few times to equalise the cable runs.

7 Tighten the locknut onto the adjuster nut finger tight, then tighten a further three to six clicks using self-locking pliers or a peg spanner.

## 23 Handbrake cable - removal and refitting

1 Slacken the rear wheel nuts and chock the front wheels. Raise and support the rear of the vehicle and remove both rear wheels. Release the handbrake.

2 Slacken off the handbrake cable adjuster locknut and adjuster nut.

3 Free the cable from the equaliser yoke by removing the circlip and clevis pin (see illustration). Beware of self-tapping screws protruding through the floor in this area.



**22.3 Handbrake cable adjuster**  
*Locknut previously backed off adjuster nut*

4 Unhook the cable inner from the handbrake levers on the calipers. Free the cable outer from the caliper brackets (see illustration).

5 Free the cable from the lower arm and underbody brackets and remove it.

6 Refit by reversing the removal operations, but before refitting the rear wheels, adjust the cable as described in the previous Section.

## 24 Handbrake control lever - removal and refitting

1 Chock the front wheels and release the handbrake. Raise and support the rear of the vehicle.

2 Disconnect the battery negative lead.

3 Disconnect the handbrake cable equaliser yoke by removing the circlip and clevis pin.

4 Remove the centre console (Chapter 12).

5 Remove the handbrake control lever boot.

6 Disconnect the wiring from the handbrake warning switch.

7 Unbolt the handbrake lever and remove it, complete with switch. Remove the switch if necessary.

8 Refit by reversing the removal operations.

## 25 ABS module - removal and refitting

1 Remove the under-dash trim on the passenger's side.

2 Push the module upwards and then swing it forwards to release it from its clip.



**22.4 Alignment marks painted on lever and body**



**23.3 Circlip (arrowed) on equaliser yoke**  
*Note protruding screws in transmission tunnel*



**23.4 Handbrake cable outer attached to caliper bracket**





26.3 Removing a front sensor

- 3 Press the multi-plug locking lever, disconnect the multi-plug and unhook it from the module. Remove the module.
- 4 Refit by reversing the removal operations. Make sure that the multi-plug is properly engaged before refitting the module.

**26 Wheel sensors - removal and refitting**



**Front**

- 1 Ensure that the handbrake is applied. Raise and support the front of the vehicle.
- 2 From under the bonnet disconnect the wheel sensor wiring multi-plug. Unclip the wiring, working towards the sensor.
- 3 Remove the securing bolt and withdraw the sensor from the stub axle carrier (see illustration).
- 4 Unclip the wire from the bracket on the strut. Remove the sensor and its wiring (see illustration).
- 5 Clean any rust or debris from the sensor bore in the stub axle carrier. Pack the bore with clean wheel bearing grease.
- 6 Renew the O-ring on the sensor and smear it with grease.
- 7 Refit by reversing the removal operations.

**Rear**

- 8 Chock the front wheels and release the handbrake. Slacken the rear wheel nuts, raise

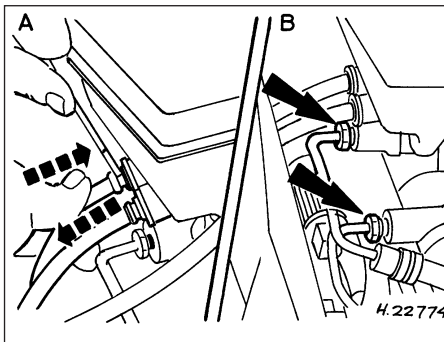

27.4 Disconnecting the master cylinder low pressure hoses (A) and brake pipes (B) - models from April 1992



26.4 Unclipping the sensor wire from the strut

- and support the rear of the vehicle and remove the rear wheel.
- 9 Fold the rear seat cushion forwards, remove the side kick panel and roll back the carpet to gain access to the sensor multi-plug (see illustration).
- 10 Disconnect the multi-plug, release the floor grommet and pass the cable through the floor.
- 11 Unclip the handbrake cable from the suspension lower arm.
- 12 Remove the caliper front slide bolt and pivot the caliper rearwards to gain access to the sensor.
- 13 Remove the sensor securing bolt and withdraw the sensor.
- 14 Clean up the sensor bore, pack it with grease and renew the sensor O-ring.
- 15 Refit by reversing the removal operations.

**27 Master cylinder (April 1992 on) - removal and refitting**



- 1 Disconnect the battery negative terminal.
- 2 Disconnect the wiring plug then remove the master cylinder reservoir cap; do not invert the cap as hydraulic fluid could enter and damage the reservoir level switch. Siphon the hydraulic fluid from the reservoir. **Note: Do not syphon the fluid by mouth, as it is poisonous; use a syringe or an old poultry baster.** Alternatively, open any convenient bleed screw in the system and gently pump the brake pedal to expel the fluid through a plastic tube connected to the screw.
- 3 Wipe clean the area around the brake pipe unions on the right-hand side of the master cylinder and place absorbent rags beneath the pipe unions to catch any surplus fluid.
- 4 To disconnect the plastic low pressure hoses, use a small flat bladed screwdriver to carefully press the flange of the collet into the master cylinder then pull the hoses out from the reservoir (see illustration). Unscrew the two union nuts and disconnect the brake pipes from master cylinder. Plug or tape over the pipe/hose ends and master cylinder orifices to minimise the loss of brake fluid and to prevent the entry of dirt into the system. Wash off any spilt fluid immediately with cold water.

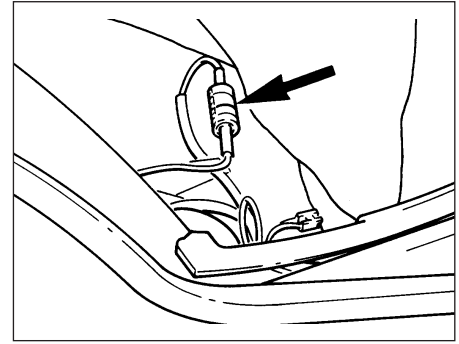

26.9 Rear wheel sensor multi-plug (arrowed)

- 5 Slacken and remove the two nuts securing the master cylinder to the vacuum servo unit then withdraw the unit from the engine compartment. Remove the O-ring from the rear of master cylinder and discard it.
- 6 If necessary remove the reservoir from the master cylinder and withdraw the mounting bush seals and O-rings. Note that the master cylinder is a sealed unit with no spare parts available separately. Therefore if it is faulty it must be renewed as a unit.
- 7 Fit new mounting bush seals and O-rings to the master cylinder and refit the reservoir (if removed). Remove all traces of dirt from the master cylinder and servo unit mating surfaces and fit a new O-ring onto the master cylinder body.
- 8 Fit the master cylinder to the servo unit ensuring that the pushrod enters the servo unit bore centrally. Refit the master cylinder mounting nuts and tighten them to the specified torque.
- 9 Wipe clean the brake pipe/hose unions and the master cylinder ports. Refit the pipes to the master cylinder ports and tighten them securely. Push the low pressure hoses into position and check they are securely held by their retaining collets.
- 10 Refill the master cylinder reservoir with new fluid and bleed the hydraulic system

**28 Vacuum servo unit (April 1992 on) - testing, removal and refitting**



- 1 To test the operation of the servo unit depress the footbrake several times to exhaust the vacuum then start the engine whilst keeping the pedal firmly depressed. As the engine starts there should be a noticeable "give" in the brake pedal as the vacuum builds up. Allow the engine to run for at least two minutes then switch it off. If the brake pedal is now depressed it should feel normal, but further applications should result in the pedal feeling firmer, with the pedal stroke decreasing with each application.
- 2 If the servo does not operate as described, inspect the servo unit check valve as described in paragraph 3 of Section 29.

3 If the servo unit still fails to operate satisfactorily the fault lies within the unit itself. Repairs to the unit are not possible.

4 Remove the master cylinder (Section 27).

5 Disconnect the vacuum hose from the servo unit taking care not to displace the rubber sealing grommet. Disconnect the wiring plug from the Pedal Travel Sensor (PTS) which is situated on the front of the servo.

6 Working from inside the vehicle, remove the servo pushrod retaining clip from the brake pedal. If necessary, to improve access to the brake pedal remove the right-hand lower facia panel.

7 Slacken and remove the four nuts securing the servo unit to the bulkhead, then return to the engine compartment and remove the servo unit from the vehicle. Remove the gasket from the rear of the unit and discard it.

8 Note that the vacuum servo unit is a sealed assembly with no spare parts available separately. Therefore if it is faulty it must be renewed as a unit. Inspect the vacuum servo vacuum hose sealing grommet for damage or deterioration and renew if necessary.

9 Remove all traces of dirt from the servo unit and bulkhead mating surfaces and fit a new gasket onto the rear of the servo.

10 Manoeuvre the servo unit into position, ensuring that the servo unit pushrod is correctly located with the hole in the pedal. Refit the servo unit retaining nuts and tighten them to the specified torque setting. Secure the pushrod in position with the retaining clip.

11 Carefully refit the vacuum hose to the servo unit taking great care not to damage or displace the sealing grommet. Reconnect the wiring connector to the Pedal Travel Sensor (PTS).

12 Refit the master cylinder as described above. On completion start the engine and check the operation of the servo unit.

### 29 Vacuum servo unit check valve (April 1992 on) - removal, testing and refitting

1 Disconnect the vacuum hose from the servo unit taking care not to displace the rubber sealing grommet.

2 To disconnect the hose from the inlet manifold, use a small flat-bladed screwdriver to carefully press the flange of the collet into the manifold then pull the hose out and remove it from the vehicle (see illustration).

3 Examine the vacuum hose and sealing grommet for damage, splits, cracks or general deterioration and renew as necessary. Make sure that the check valve is working correctly by blowing through the hose from the servo unit end. Air should flow in this direction, but not when blown through from the inlet manifold hose end. Renew the check valve if it is at all suspect.

4 Ensure that the check valve is fitted the correct way around then push the connector into the manifold and check that it is securely held by the retaining collet.

5 Carefully refit the vacuum hose to the servo unit taking great care not to damage or displace the sealing grommet.

6 On completion start the engine and check the operation of the servo unit.

### 30 Valve block and pump assembly (April 1992 on) - removal and refitting

1 Disconnect the battery negative terminal.

2 Carry out the operations described in paragraphs 2 to 4 of Section 27.

3 Remove all traces of dirt from the exterior of the block then disconnect the motor and valve block wiring plugs and free the diagnostic test wiring plug from the mounting bracket.

4 Position some absorbent rag beneath the valve block then unscrew the three brake pipe outlet unions whilst avoiding getting surplus brake fluid in the wiring plugs. Plug the block ports and pipe ends to minimise the loss of fluid and prevent the entry of dirt into the system. Wash off any spilt fluid immediately with cold water.

5 Slacken and remove the three valve block and pump assembly mounting nuts and remove the unit from the engine compartment.

6 Note that the valve block and pump assembly is a sealed unit and cannot be overhauled. If it is faulty it must be renewed. Note that if the low pressure hoses are disconnected from the assembly, great care must be taken when reconnecting them to ensure that the valve block filter is not damaged.

7 Manoeuvre the assembly into position then refit the mounting nuts and tighten them by hand only. Taking into account the amount of movement in the mounting rubbers, position the assembly so that it will not contact the mounting bracket then tighten the mounting nuts to the specified torque setting.

8 Remove the plugs then reconnect the outlet pipes to the assembly and tighten the union nuts securely.

9 Ensure that the wiring is correctly routed and reconnect the wiring plugs to the valve block and pump assembly. Refit the



29.2 Disconnecting brake servo vacuum hose from the inlet manifold (DOHC engine shown)

diagnostic test wiring connector to the mounting bracket.

10 Wipe clean the brake pipe/hose unions and the master cylinder ports. Refit the pipes to the master cylinder ports and securely tighten the union nuts. Push the low pressure hoses into position and check they are securely held by their retaining collets.

11 Reconnect the battery negative terminal, then fill the master cylinder and bleed the complete hydraulic system using the information given earlier in this Section.

### 31 Control module (April 1992 on) - removal and refitting

1 The anti-lock braking control module is located behind the glovebox. To remove the module first disconnect the battery negative terminal.

2 Open up the glovebox then, using a small flat-bladed screwdriver, carefully prise up the retaining clip and disconnect the glovebox hinge arms. Withdraw the glovebox assembly from the facia noting the plastic bushes which are fitted to the glovebox pivot points.

3 Lift the wiring plug retaining clip and disconnect the plug to the control module. The ABS module is the upper of the two control modules mounted horizontally.

4 Release the retaining clips and slide the module out of the mounting bracket (see illustration).

5 Commence refitting by sliding the module into the mounting bracket until it clips into position.

6 Connect the wiring connector to the module, ensuring that the wiring is correctly routed, and secure it in position with the retaining clip.

7 Ensure that the plastic bushes are correctly fitted to the glovebox then refit the glovebox assembly, locating the pivots in the correct locations on the facia panel. Clip the hinge arms onto the glovebox and check that it opens and closes smoothly.

8 Reconnect the battery negative terminal.



31.4 Removing the ABS control module - models from April 1992

**32 Pedal Travel Sensor (PTS)  
(April 1992 on) - removal and  
refitting**



- 1 Disconnect the battery negative terminal then deplete the vacuum in the braking system servo unit by depressing the footbrake several times.
- 2 Disconnect the wiring plug from the sensor which is situated on the front of the vacuum servo unit.
- 3 Using a small flat-bladed screwdriver, prise off the retaining circlip, then carefully withdraw the sensor from the servo unit taking great care not to displace the sealing O-ring (see illustration). **Note:** *If the O-ring becomes displaced and falls into the servo unit it must be recovered before the sensor is refitted.*
- 4 If the sensor is to be renewed, ensure that the tip of the new sensor pushrod is the same colour as that of the original.
- 5 Fit a new O-ring to the sensor and apply a

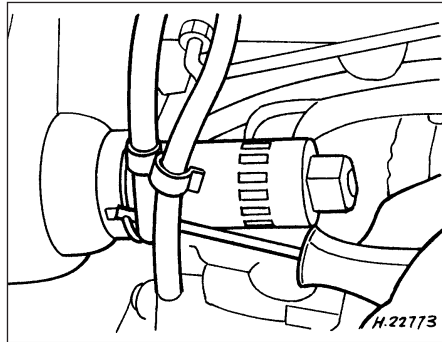

**32.3 Removing the Pedal Travel Sensor (PTS) circlip - models from April 1992**

smear of clean engine oil to it to ease installation.

**6** Ease the sensor into position in the servo unit, taking care not to displace the O-ring, and secure it in position with the circlip.

**7** Reconnect the sensor wiring connector and the battery negative terminal.

**33 G (gravity) switch (April 1992  
on) - removal and refitting**



- 1 Remove the driver's seat as described in Chapter 12.
- 2 Carefully peel back the carpet from immediately behind the crossmember to reveal the G switch.
- 3 Disconnect the wiring connector then undo the two retaining screws and remove the switch from the vehicle.
- 4 Refitting is a reversal of the removal procedure.